

Main Features

- Control circuit and RGB chips are integrated in one 5050 package components, constitute a complete external control pixels.
- DC12V power supply, effectively reduce the working current of the whole pixel, lower PCB board's voltage drop, to the greatest extent Guarantee the pixels in a good mix of light consistency when long distance transmission.
- Using the built-in signal reshaping circuit to achieve the signal waveform shaping, and no distortion accumulate of waveform when signaling;
- Built-in signal shaping circuit, any one pixel point again after received signal waveform shaping output, ensure the line waveform distortion does not accumulate;
- The gray levels of each pixel are of 256 levels, which achieves "256*256*256=16777216" full-color display, and
- Port refresh frequency reaches to 2kHz;
- Serial cascade interface: data receiving and decoding depend on just one signal wire;
- Dual-signal wires version, additional one signal wire, signal break-point continuous transmission;
- Any two points' transmission distance no more than 5m, there is no need to add any circuit;
- When the refresh rate is 30fps, cascade pixels are no less than 1024 pixels;
- Data transmitting at speeds of up to 800Kbps.
- Good color consistency reliability, high cost-effective.

Main Application

- LED Shoes light, Digital products, S style flexible strip, Architectural model, etc;
- LED curtain screen, LED pixel screen, LED Special-shaped screen;

General Description

WS2815-MINI is an intelligent control LED light source that the control circuit and RGB chip are integrated in a package of 3535 components, outlook is the same as 5050 LED; Any components is a pixel; Its internal includes intelligent digital port data latch and signal reshaping amplification drive circuit. Also include a precision internal oscillator and a programmable constant current control part, which achieves highly consistent color effect. Realize double signal transmission, if any pixel failure, it won't affect the whole display;

The data transfer protocol use single NZR communication mode. After the pixel power-on reset, the DIN port receive data from controller, the first pixel collect initial 24bit data then sent to the internal data latch, the other data which reshaping by the internal signal reshaping amplification circuit sent to the next cascade pixel through the DO port. After transmission for each pixel, the signal to reduce 24bit. Every pixel adopts auto-reshaping transmit technology, making the pixel cascade numbers are not limited to the signal transmission, only relate to the speed of signal transmission.

The BIN receives the data signal, and then compare the data with the DIN side after phagocytosis of 24bit data, if DIN do NOT receive the signal, then switching to BIN for receiving the input signal, which ensure that any the IC's damage does not affect the signal cascade transmission and make the BIN in state of receiving signal until restart after power-off.

Refresh Frequency updates to 2KHz, Low Frame Frequency and no Flicker appear in HD Video Camera.

300us or more of reset time, it won't cause wrong reset while interruption, it supports the lower frequency and inexpensive MCU.

Mechanical Dimensions

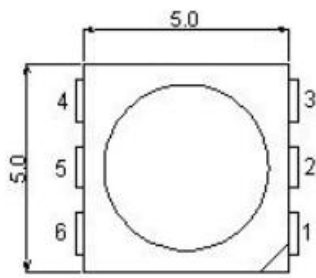

Top View

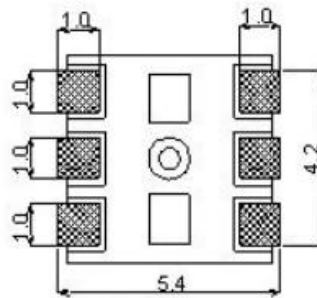

Back View

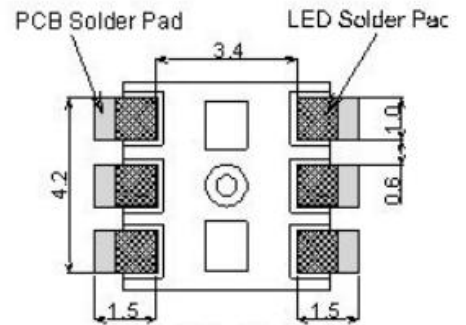

Solder Pad

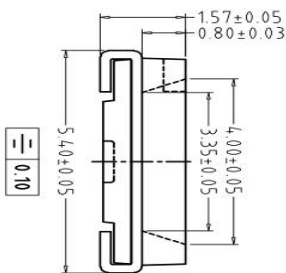

Remarks

1. Dimension: 5.0*5.0*1.57mm
2. Default tolerance: ±0.01mm

PIN Configuration:

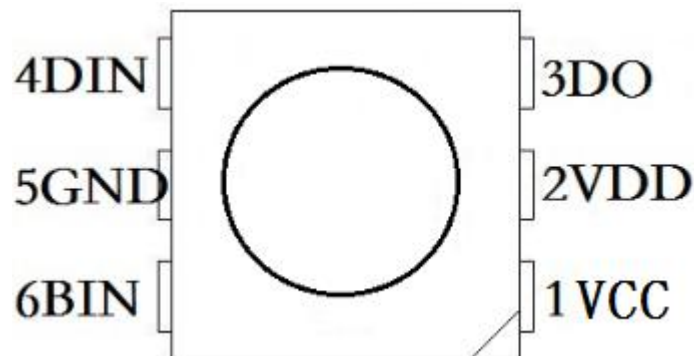

WS2815

Intelligent Control LED integrated light source

PIN Function:

Item No.	Symbol	PIN	Function Description
1	VCC	IC power supply	Internal control IC power supply, external a 0.111uf filter capacitance
2	VDD	LED power supply	LED Power supply, + 12V power supply;
3	DO	Main Data Output	Control data signal output
4	DIN	Main Data Input	Control data signal input
5	GND	Ground	Data & Power Grounding
6	BIN	BACKUP DATAIN	Backup Control data signal input

Absolute Maximum Ratings (No special instructions, TA=25°C, VSS=0V)

Parameter	Symbol	Ratings	Unit
Power supply voltage	V _{DD}	+9~+13	V
Input voltage	V _I	-0.5~VCC+0.5	V
Working Temperature	T _{opt}	-25~+60	°C
Storage Temperature	T _{stg}	-40~+105	°C

Data Transfer Time (T_H+T_L=1.1μs±300ns)

T _{0H}	0-code, High-level time	220ns~420ns
T _{1H}	1-code, High-level time	750ns~1.6μs
T _{0L}	0-code, Low-level time	750ns~1.6μs
T _{1L}	1-code, Low-level time	220ns~420ns
RES	Frame unit, Low-level time	300μs or more

Sequential waveform

Input code type:

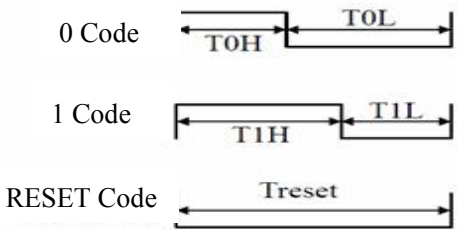

Connection Method:

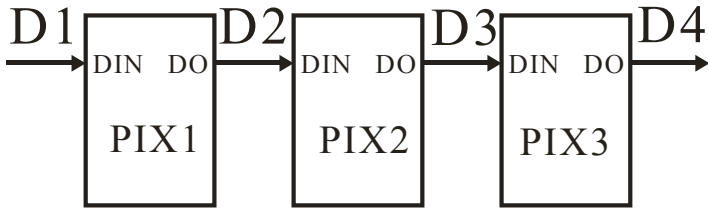

Data Transmission Method:

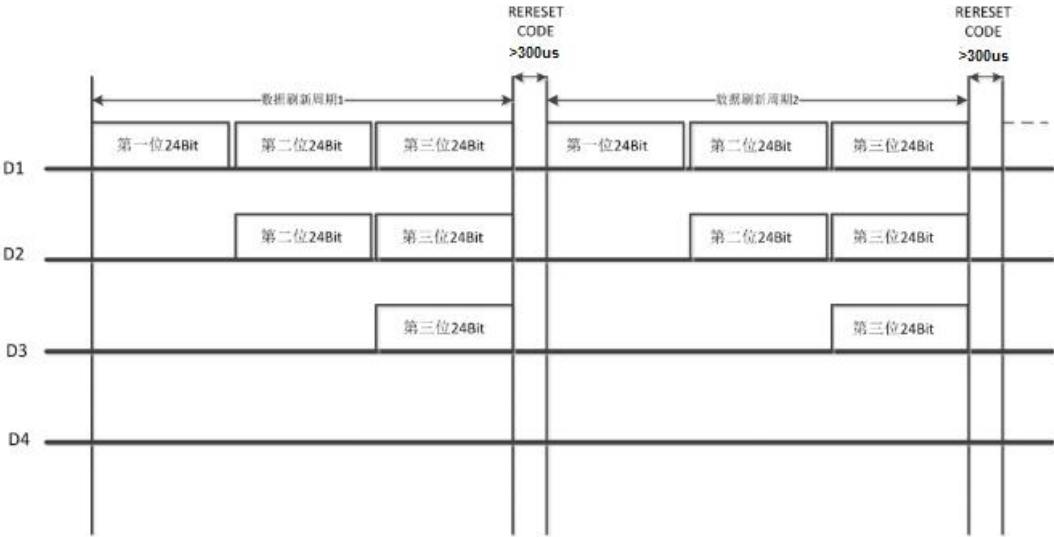

Note: D1 is the data from MCU, and D2, D3, D4 are from Cascade Circuits.

Composition of 24bit data:

R7	R6	R5	R4	R3	R2	R1	R0	G7	G6	G5	G4	G3	G2	G1	G0	B7	B6	B5	B4	B3	B2	B1	B0
----	----	----	----	----	----	----	----	----	----	----	----	----	----	----	----	----	----	----	----	----	----	----	----

Note: Data transmit in order of GRB, high bit data is first.

Typical application circuit:

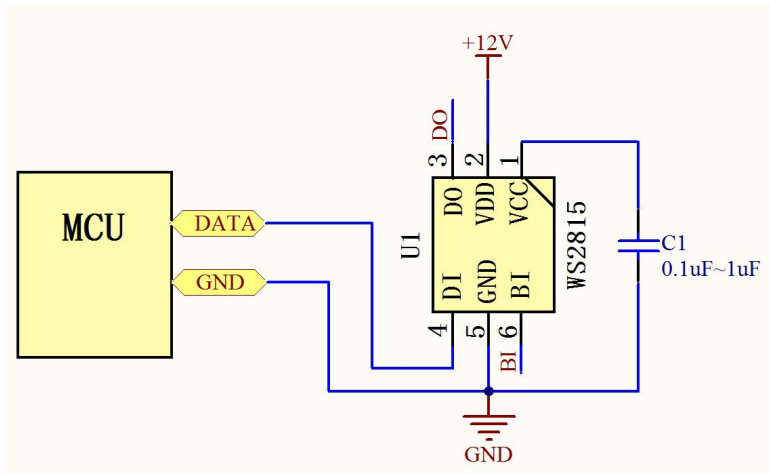

Reflow Instructions

1) Lead-free Reflow:

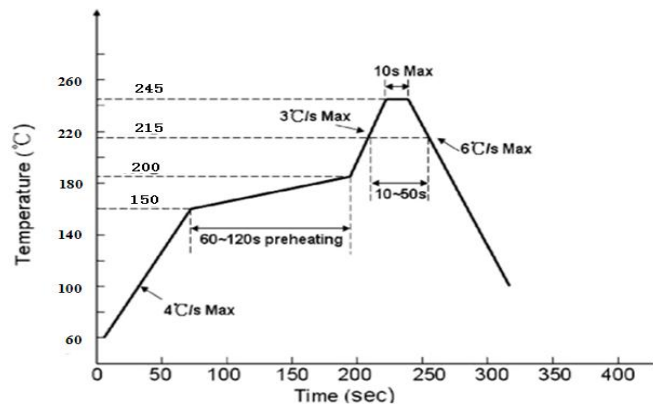

2) Leaded Reflow:

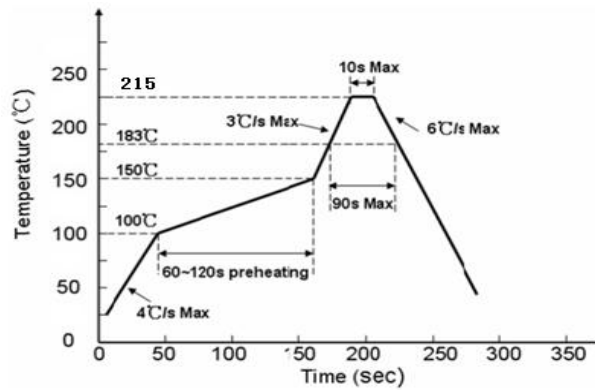

WS2815

Intelligent Control LED integrated light source

Curve Description	Lead Reflow Solder	Lead-free Reflow Solder/SMT
The lowest preheat temperature (T _{min})	100°C	150°C
The highest preheat temperature (T _{max})	150°C	200°C
Preheating time (T _{min} to T _{max}) (ts)	60-120 S	60-180 S
Average rate of temperature rise (T _{max} to T _p)	<3°C/S	<3°C/S
LIQUID REGION temperature (TL)	183°C	217°C
LIQUID REGION Holding Time (tL)	60-150 S	60-150 S
Peak Temperature (T _p)	215 °C	245°C
High Temperature Region(T _p =-5°C) Holding Time (tp)	<10 S	<10 S
Cooling Speed Rate	<6°C/S	<6°C/S
Room Temperature to Peak Holding Time	<6 min	<6 min

Remarks

1. This has to be baked for 48 hours at the baking temperature of 65-70°C before being used.
2. Use up with 2 hours after taking out from oven.
3. Please replace the unused LEDs into oven.

Reflow explanation

1. No more than two times of reflow.
2. Do not beat the colloid surface when the material is heated.

Manual Soldering instruction:

1. Soldering iron's temperature must be under 300°C, and operating time must be less than 3 seconds.
2. It should be done only once for the manual soldering.

Repairing instruction:

Normally, it can't be repaired after reflow. You need to use double-ended solder iron and make sure that whether it will do damage to the LEDs' characteristics when repairing is inevitable.

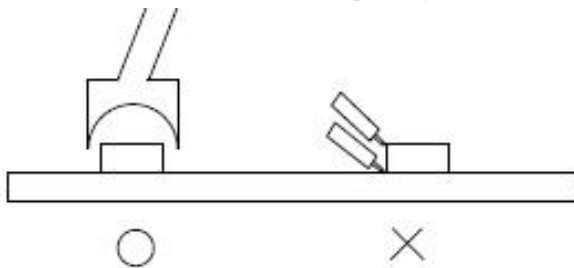

1.Storing

1.Scope of application

Front side up, moisture-proof and waterproof, no extrusion, no collision and no vibration.

2.Storage and its period

- ① Room temperature sealed storage: 20°C~30°C, 40%~60%RH, product is valid for ONE month.
- ② Moisture-proof sealed storage: 20°C~30°C, 25%~60%RH, product is valid for THREE month.
- ③ Use up with 2 hours after removing from packages.(Environmental conditions for temperature <30°C, relative humidity<60%)

3.Dehumidification

We would recommend to do dehumidification if they exceed the valid storage period of products or dampened due to other reasons.

Dehumidification Method: 70°C-75°C/22±2 Hours

4.Electrostatic Protection

LED is an electrostatic sensitive component, although the LED products are with excellent anti-static ability, they will cause a certain damage by any electrostatic discharge. By taking some electrostatic measures to avoid the damages when using the LEDs, such as wearing anti-static gloves and anti-static bracelet, etc.

5.Attention

Pressing the colloid surface will affect the reliability of LED because the LED is advanced silicone-gel.And therefore precautions should be taken to avoid the strong pressure on the component. It's proper to make the LED be used in safe condition when using a suction nozzle. Silicon packing with soft and elastic, it greatly reduces thermal stresses and unable to bear external mechanical forces. Therefore, preventive measures should be taken in process of manually handling.

- 1). Clip the LED from its side

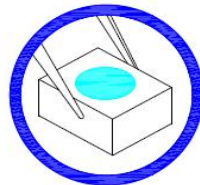

- 2). Neither directly touch the gel surface with the hand or sharp instrument, it may damage its internal circuit.

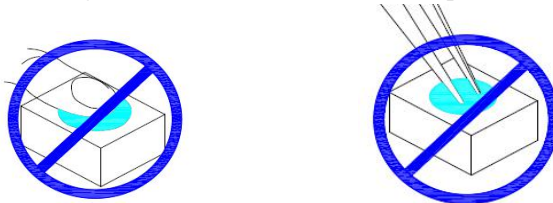

- 3). Don't stack the leds together, it may damage its internal circuit.

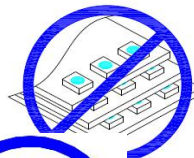

- 4).Can not be stored in or applied in the acidic sites of PH<7.



WS2815 Intelligent Control LED integrated light source

Label

P/N:

Quantity:

Packing:

Date:

P/N:WS2815

Quantity:1000pcs



Packing:SMD-5050

Date:20170117



Carrier tape (Unit: mm)

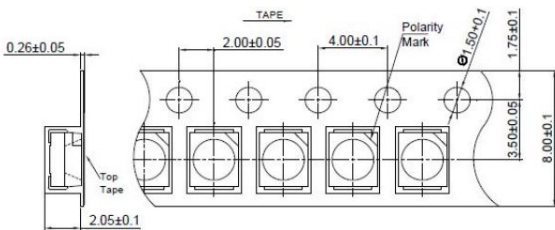

Reel size (Unit: mm)

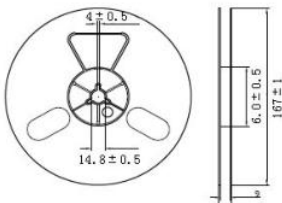

Moisture-proof bag

